

PROFILE DRAWINGS

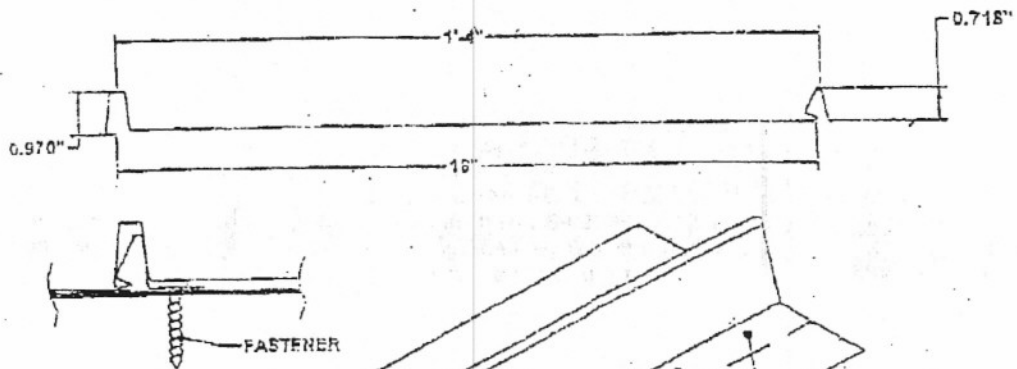

Fastener size:
#10-13 Type A
Pancake

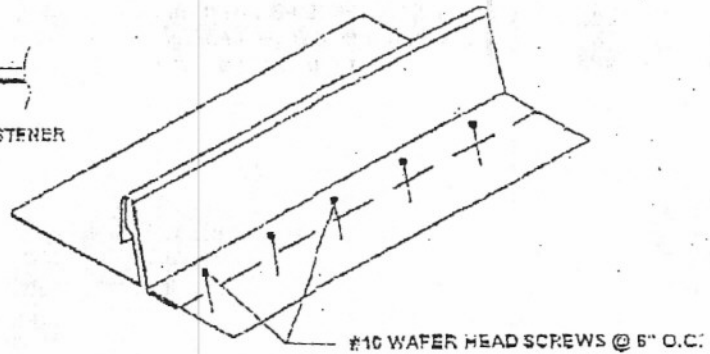

"NAIL STRIP" METAL ROOF PANELS

END OF THIS ACCEPTANCE

State of Florida
C.O.A.
26778



December 17, 2008

26 Ga. 1" Versa Lock 16" coverage over 15/32" plywood

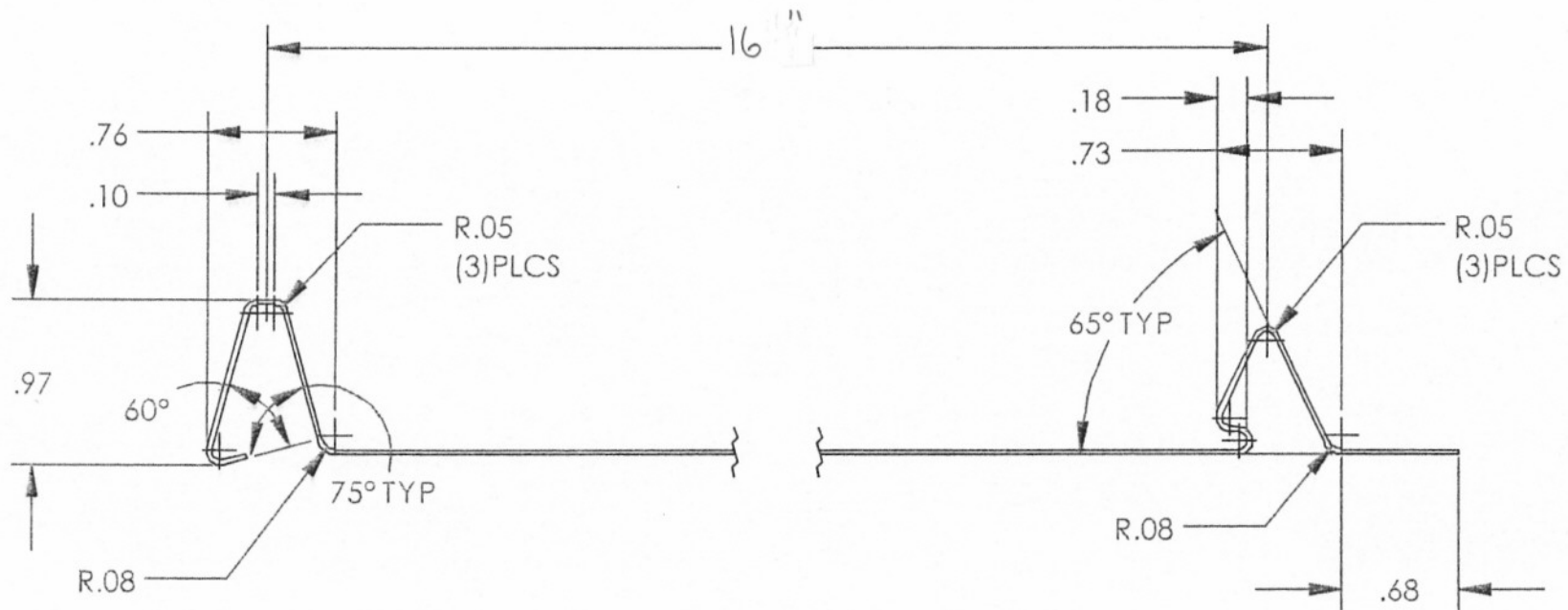

State of Florida
C.O.A.
26778



PANEL DIMENSIONS +/- 10%

PROFILE:
1-in Nail Strip

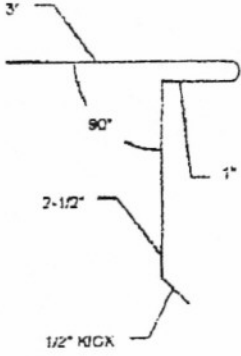
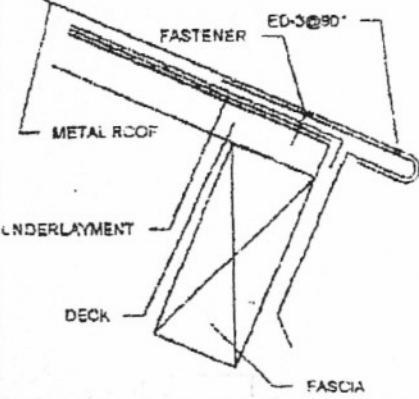

December 17, 2008

24-

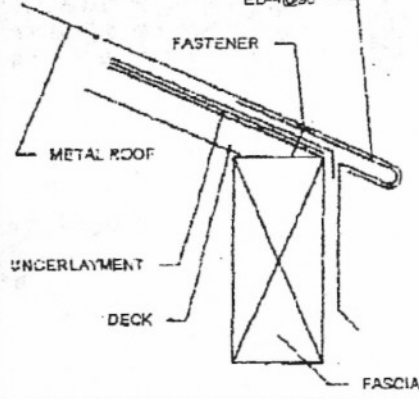
PROFILE	PART NO.	STRETCH OUT OF MATERIAL	DETAIL
	ED-3	8"	 <p>NOTE: DETERMINE IF FASCIA IS AT 90° OR PITCHED</p>
	ED-4	8"	 <p>NOTE: DETERMINE IF FASCIA IS AT 90° OR PITCHED</p>
			<p>NAIL STRIP DETAIL</p> <p>NS-1</p>

State of Florida
C.O.A.
26778

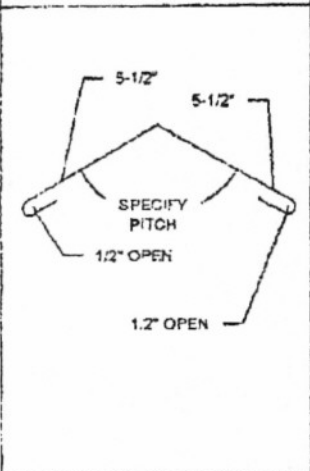
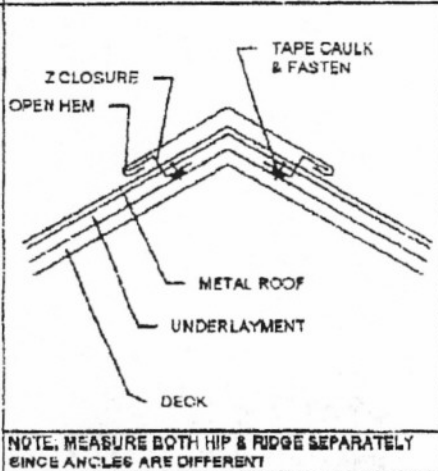
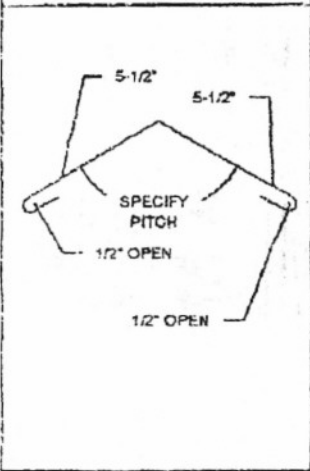
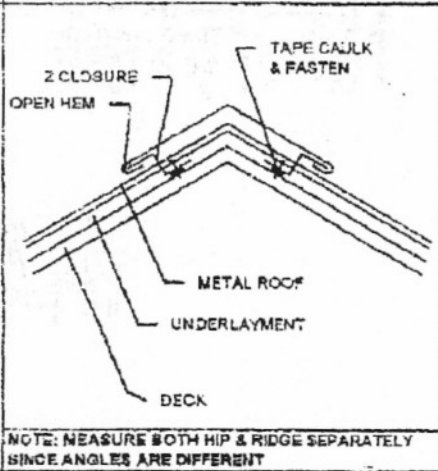

PROFILE	PART NO	STRETCH OUT OF MATERIAL	DETAIL
	H-4	12"	
	R-4	12"	
			<p style="text-align: center;">NAIL STRIP DETAIL</p> <p style="text-align: right;">NS-2</p>

State of Florida
C.O.A.
26778



December 17, 2008

PROFILE	PART NO.	STRETCH OUT OF MATERIAL	DETAIL
	V-1	20"	
	V-2	20"	<p data-bbox="893 1342 1273 1364">NOTE: V2 GAUGE USED IN LOW SLOPE AREAS</p>
			<p data-bbox="987 1406 1240 1438">NAIL STRIP DETAIL</p> <p data-bbox="1281 1442 1326 1461">NS-3</p>

State of Florida
C.O.A.
#26778



December 17, 2008

04

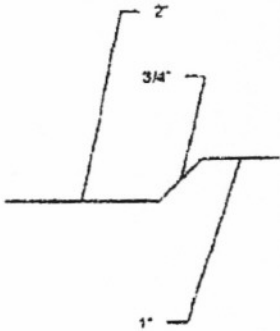
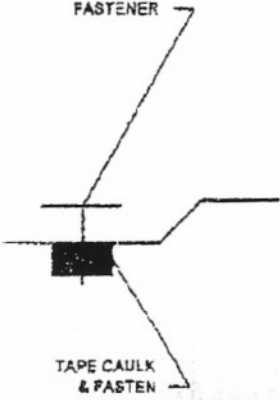
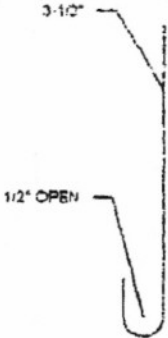
PROFILE	PART NO.	STRETCH OUT OF MATERIAL	DETAIL
	OC-1	3-3/4"	 <p data-bbox="930 901 1340 944">NOTE: OC-1 CAN BE USED IN VALLEY/TRANSITION FLASHING/OR ANY CLEFT AREA</p>
	J-1	4"	
			<p data-bbox="1021 1435 1273 1468">NAIL STRIP DETAIL</p> <p data-bbox="1312 1474 1350 1489">NS-4</p>

State of Florida
C.O.A.
26778

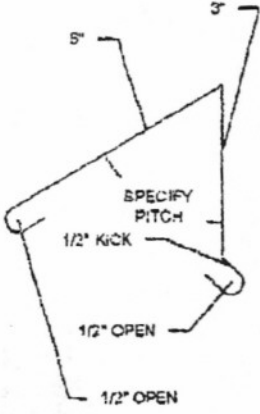
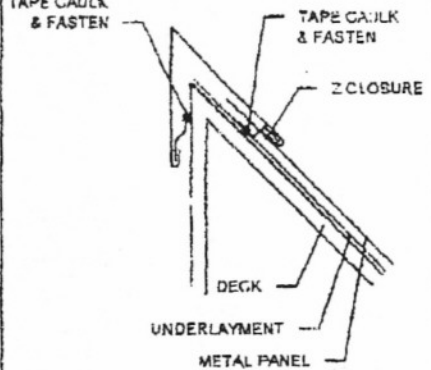
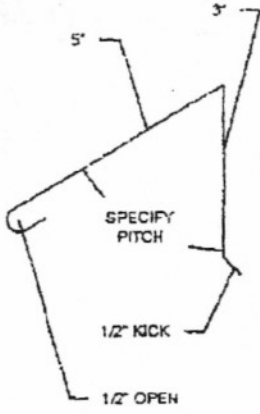

December 17, 2008

PROFILE	PART NO.	STRETCH OUT OF MATERIAL	DETAIL
 <p>5" 3" SPECIFY PITCH 1/2" KICK 1/2" OPEN 1/2" OPEN</p>	P-2/0	9-1/2"	 <p>TAPE CAULK & FASTEN TAPE CAULK & FASTEN Z CLOSURE DECK UNDERLAYMENT METAL PANEL</p> <p>NOTE: USE C-1 CLEAT IF NEEDED</p>
 <p>5" 3" SPECIFY PITCH 1/2" KICK 1/2" OPEN</p>	P-2	9"	
			<p>NAIL STRIP DETAIL</p> <p>NS-5</p>

State of Florida
C.O.A.
26778



December 17, 2008

26 Ga. 1" Versa Lock 16", coverage over 15/32" plywood

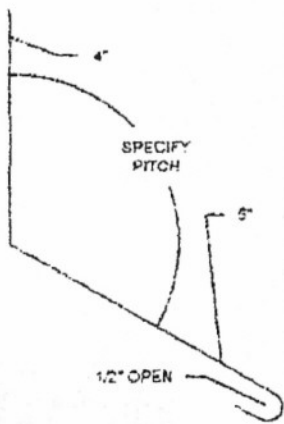
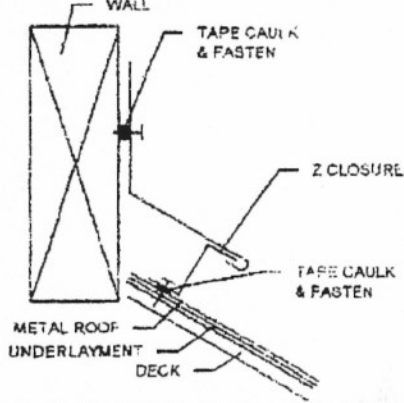
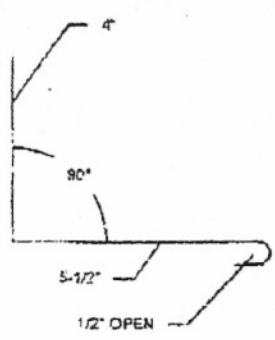
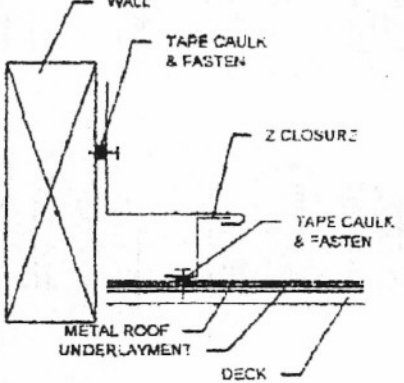
PROFILE	PART NO.	STRETCH OUT OF MATERIAL	DETAIL
	RW-2/O	10"	
	RW-5/O	10"	
			<p>NAIL STRIP DETAIL</p> <p style="text-align: right;">NS-6</p>

State of Florida
C.O.A.
26778

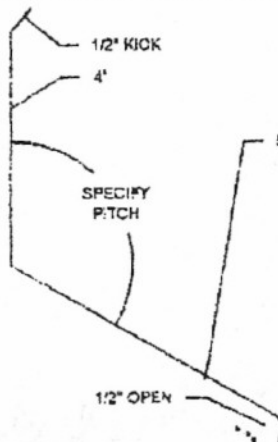
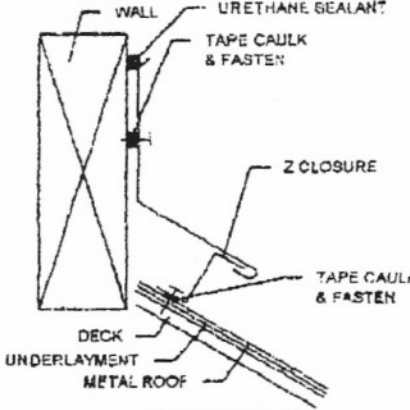
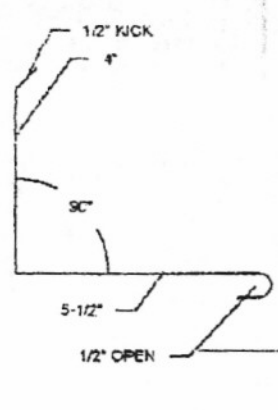
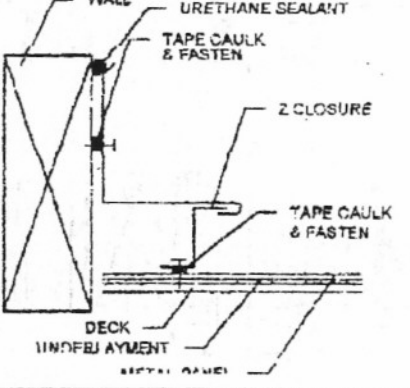

December 17, 2008

PROFILE	PART NO.	STRETCH OUT OF MATERIAL	DETAIL
	RWK-2/O	10"	 <p>NOTE: THIS IS A SURFACE MOUNT ASSEMBLY</p>
	RWK-5/O	10"	 <p>NOTE: THIS IS A SURFACE MOUNT ASSEMBLY</p>
			<p>NAIL STRIP DETAIL</p> <p style="text-align: right;">NS-7</p>

State of Florida
C.O.A.
26778

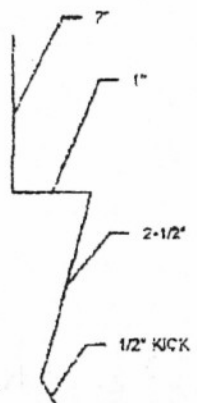
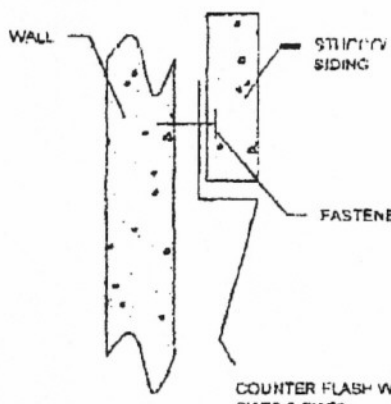
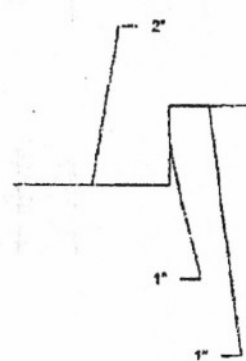
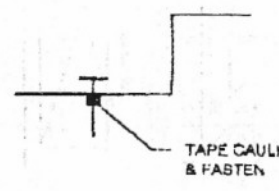

PROFILE	PART NO.	STRETCH OUT OF MATERIAL	DETAIL
	SS-1	6"	 <p>COUNTER FLASH W/ RW20 & RW50</p> <p>NOTE: STUCCO/SIDING STOP CAN BE INSTALLED SO OTHER TRADES CAN WORK BEFORE ROOFING</p>
	Z-1	4"	 <p>TAPE CAULK & FASTEN</p> <p>NOTE: Z CLOSURE IS FIELD CUT TO FIT BETWEEN RIBS; TYPICAL DETAILS H-4, P-2/O, RW-2/O, RW-5/O, RK-4, RK-5, SK-2, BK-3, TF-2/O, & FL-2/O</p>
			<p>NAIL STRIP DETAIL</p> <p>NS-8</p>

State of Florida
C.O.A.
26778

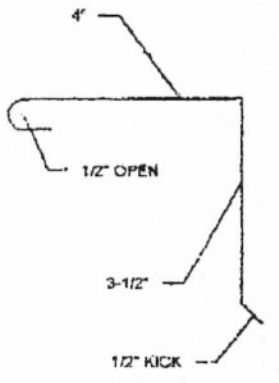
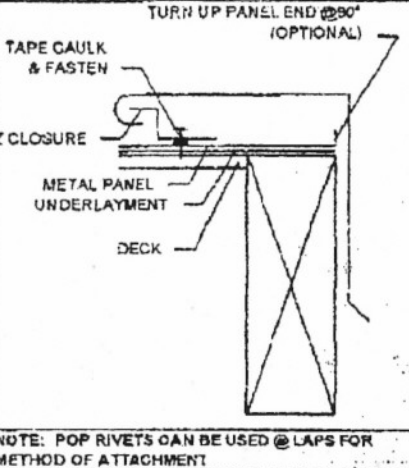
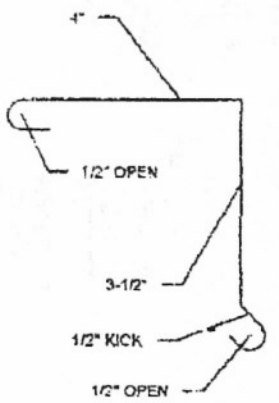
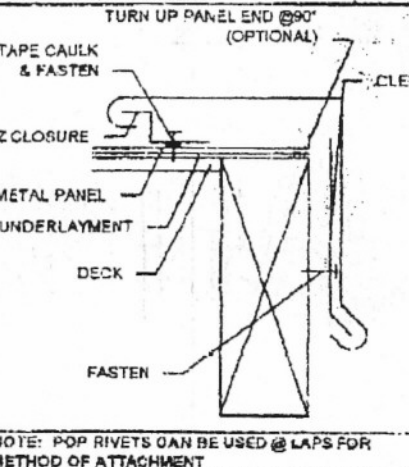

December 17, 2008

PROFILE	PART NO.	STRETCH OUT OF MATERIAL	DETAIL
	RK-4	8-1/2"	
	RK-5	9"	
			<p style="text-align: center;">NAIL STRIP DETAIL</p> <p style="text-align: right;">NS-9</p>

State of Florida
C.O.A.
26778



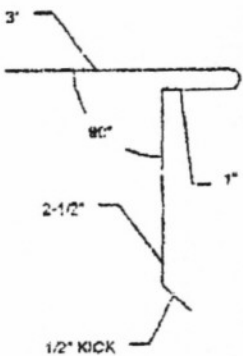
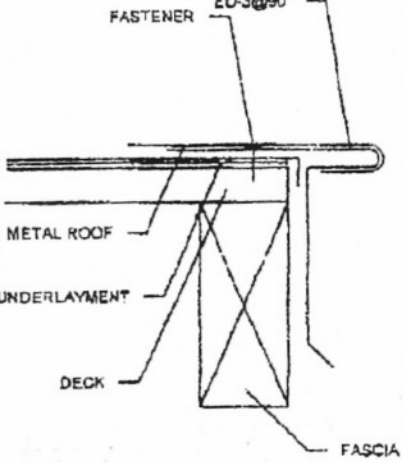

December 17, 2008

PROFILE	PART NO.	STRETCH CUT OF MATERIAL	DETAIL
 <p>3"</p> <p>1/2" KICK</p> <p>2-1/2"</p> <p>1"</p> <p>ALTERNATE GABLE/RIDGE DETAIL</p>	<p>ED-3</p>	<p>B</p>	 <p>FASTENER ED-3 @ 90°</p> <p>METAL ROOF</p> <p>UNDERLAYMENT</p> <p>DECK</p> <p>FASCIA</p> <p>NOTE: REFER TO ED-3 DETAIL</p> <p>SOME CONTRACTORS LIKE TO FOLD THE PANEL OVER THE GABLE/RAKE CONDITION BY CUTTING THE PANEL OVER AND FOLDING THE EDGE AROUND THE ED-3.</p>
			<p>NAIL STRIP DETAIL</p> <p>NS-10</p>

State of Florida
C.O.A.
26778

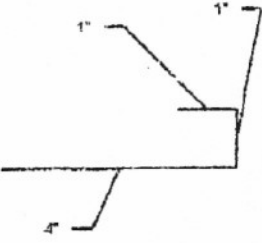
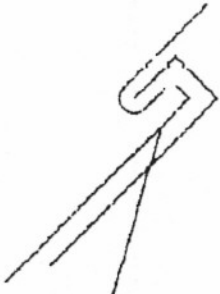

December 17, 2008

PROFILE	PART NO.	STRETCH OUT OF MATERIAL	DETAIL
	JC-1	5"	 <p>PANEL MUST BE FOLDED UP @ TOP</p> <p>NOTE: SOMETIMES IT IS NECESSARY TO PRE-INSTALL FLASHINGS DUE TO STEEP SLOPE</p>
	C-1	3-1/2"	<p>NOTE: USE ON P-20 OR RK-6</p>
			<p>NAIL STRIP DETAIL</p> <p>NS-11</p>

State of Florida
C.O.A.
26778



December 17, 2008

26 Ga. 1" Versa Lock 16" coverage over 15/32" plywood

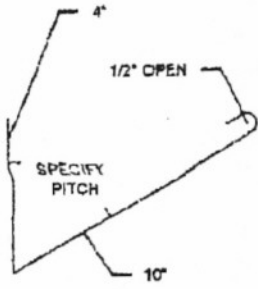
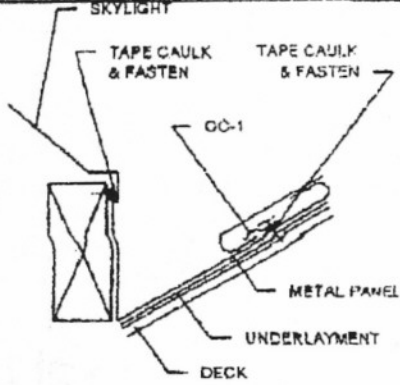
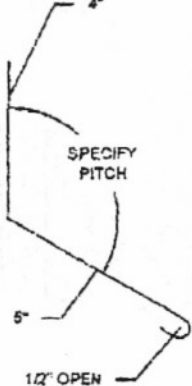
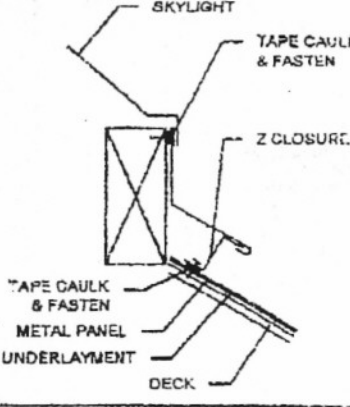
PROFILE	PART NO.	STRETCH OUT OF MATERIAL	DETAIL
	SK-1	14-1/2"	 <p>NOTE: BACKSPLASH FOR SKYLIGHT; GC-1 REQUIRED</p>
	SK-2	10	
			<p>NAIL STRIP DETAIL</p> <p style="text-align: right;">NS-12</p>

State of Florida
C.O.A.
26778

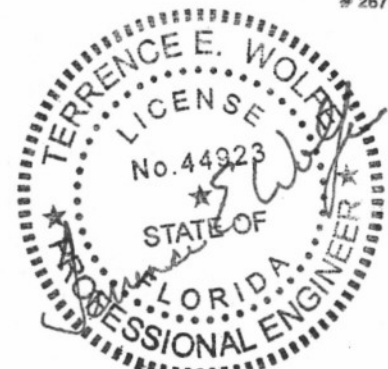

December 17, 2008

26 Ga. 1" Versa Lock 16" coverage over 15/32" plywood

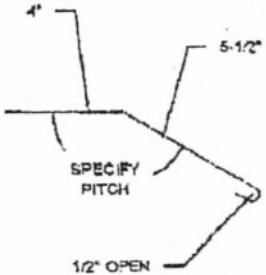
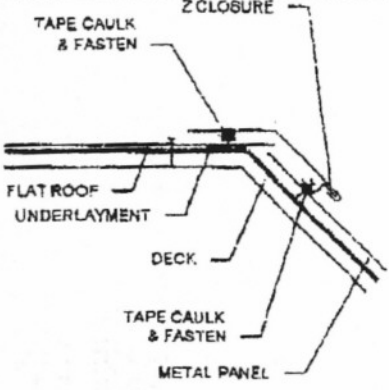
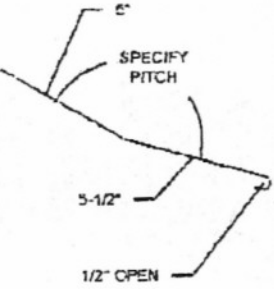
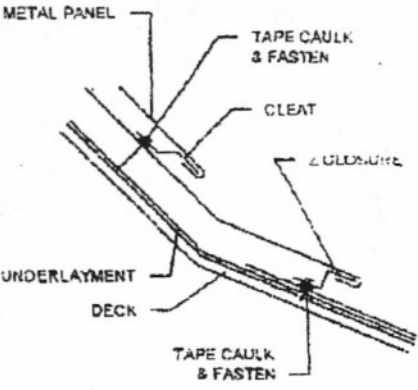
PROFILE	PART NO.	STRETCH OUT OF MATERIAL	DETAIL
	FL-2/0	10	
	TF-2/0	11"	
			<p>NAIL STRIP DETAIL</p> <p style="text-align: right;">NS-14</p>

State of Florida
C.O.A.
26778



December 17, 2008